



HYDRAULIC CYLINDERS

All cylinders are marked with maximum pressure setting

DEFINITIONS

Authorized - appointed by a duly constituted administrative or regulatory authority.

Authorized Service Center - independent service facility designated by the manufacturer to repair and test products.

Cylinders, Rams, and Jacks - used to apply force in a linear motion through the use of hydraulic fluid under pressure confined in a pressure vessel (body) with moveable pressure vessel (piston).

Designated - selected by the employer or employer's representative as being qualified to perform specific duties.

Extension - a device to increase the cylinder's, ram's or jack's retracted length.

Load - the total weight or force to be overcome by the cylinder, ram or jack.

Qualified - a person who, by possession of a recognized degree, certificate, professional standing or who by extensive knowledge, training and experience, has successfully demonstrated the ability to solve or resolve problems relating to the subject matter or work, or who is filled or suited for a given purpose or function. Competent.

Operator - a person qualified to operate or use a device or machine.

Rated Capacity - the maximum load for which the cylinder, ram, or jack is designed and built.

Service, Normal - cylinders, rams or jacks used under controlled or known consistent loads at less than 85% of rated capacity except for isolated instances.

Service, Severe - cylinders, rams or jacks used under conditions not rated as normal service.

Travel - linear extending or retracting movement of the cylinder, ram or jack.

SAFETY EXPLANATIONS

Two safety symbols are used to identify any action or lack of action that can cause personal injury. Your reading and understanding of these safety symbols is very important.



DANGER - Danger is used only when your action or lack of action will cause serious human injury or death.



WARNING - Warning is used to describe any action or lack of action where a serious injury can occur.

IMPORTANT - Important is used when action or lack of action can cause equipment failure, either immediate or over a long period of time.



WARNING: It is the operator's responsibility to read and understand the following safety statements,

- Only qualified operators should install, operate, adjust, maintain, clean, repair, or transport this machinery.
- These components are designed for general use in normal environments. These components are not specifically designed for lifting and moving people, agri-food machinery, certain types of mobile machinery or special work environments such as: explosive, flammable or corrosive. Only the user can decide the suitability of this machinery in these conditions or extreme environments. AME will supply information necessary to help make these decisions.

SINGLE-ACTING HYDRAULIC SYSTEMS

A basic single-acting hydraulic system consists of a manual or power pump that moves the hydraulic fluid, a hydraulic hose that carries the fluid, and a cylinder or ram that the fluid moves to do a job.

TYPICAL INSTALLATION

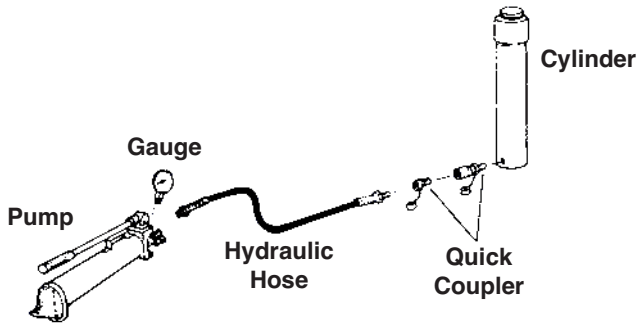

Since the single-acting cylinders have only one hose going to the cylinder, the cylinder can only apply force to extend (pull cylinders retract) its rod. The return stroke is accomplished by gravity or spring force.

VARIOUS TYPES OF SINGLE-ACTING CYLINDERS

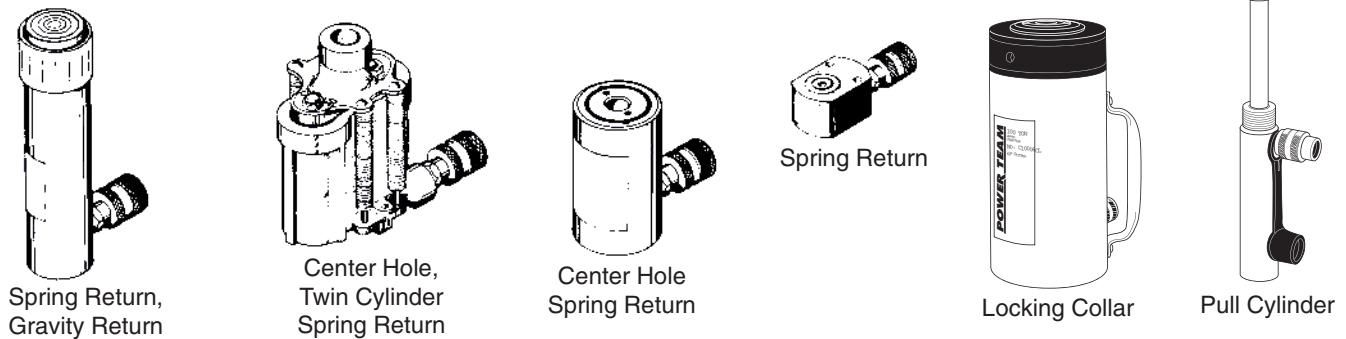

DOUBLE-ACTING HYDRAULIC SYSTEMS

A basic double-acting hydraulic system consists of a pump (which moves the hydraulic fluid), a double-acting cylinder or ram (to do the work), a hydraulic hose (which routes the fluid to the advance cylinder or ram port), a second hydraulic hose (which routes the fluid to the retract cylinder or ram port), and a control valve which can change the direction of the hydraulic fluid.

TYPICAL INSTALLATION

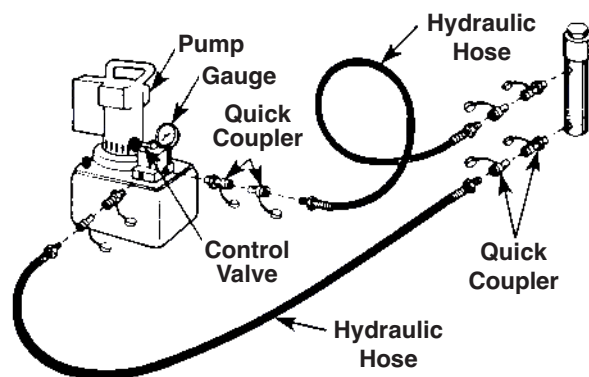

A double-acting cylinder or ram can be either extended or retracted hydraulically.

Most double-acting cylinders or rams are classed as "differential cylinders" because of the different sized areas that the hydraulic fluid pushes against during the extend and retract strokes. Because of this difference, the extend stroke can exert more force than the retract stroke.

VARIOUS TYPES OF DOUBLE-ACTING CYLINDERS

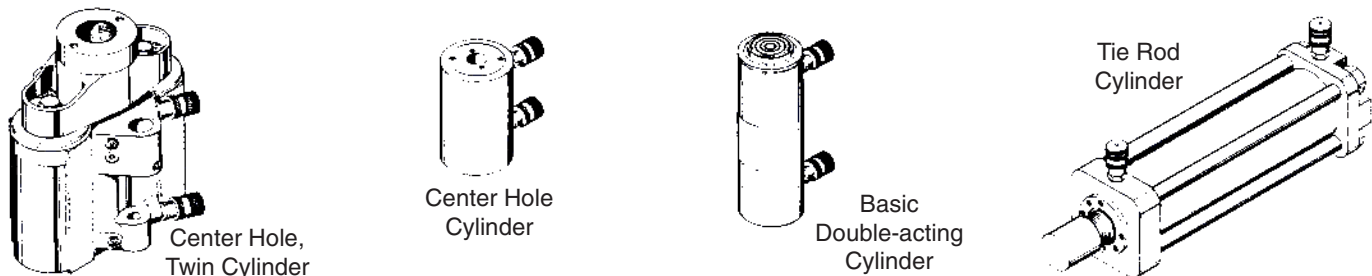

NOTE: The capacity of a hydraulic system is determined by the effective area of the cylinder and the system pressure.

SAFETY PRECAUTIONS

 **DANGER**

- A double-acting cylinder or ram must have both hoses and all couplers securely connected to both ports. If one of the two ports is restricted or becomes disconnected, pressure will build and the cylinder, hose or coupler can burst, possibly causing serious injury or death.
- When extending double-acting cylinders or rams, the retract port must not be restricted. A restricted retract port will prevent pressure from being released and the cylinder can burst, possibly causing serious injury or death.
- DO NOT attempt to adjust or service the rod end relief valve on a double-acting cylinder or ram. If oil leakage is detected from this relief valve, discontinue use of the cylinder or ram immediately and contact your nearest Authorized Hydraulic Service Center. If improperly adjusted, the cylinder or ram could develop excessive pressure and cause the cylinder, hose or couplers to burst which could cause serious injury or death.
- When extending a cylinder or ram under load, always insure that the coupler(s) or port thread(s) has (have) not been damaged or do(es) not come in contact with any rigid obstruction. If this condition does occur, the coupler's attaching threads may become stripped or pulled from the cylinder or ram resulting in the instantaneous release of high pressure hydraulic fluid, flying objects, and loss of the load. All of these possible results could cause serious injury or death.
- When using a center-hole cylinder or ram, always support the base against a rigid, flat surface at least 75% as large as the cylinder or ram base. Failure to do so can damage the center standpipe resulting in the instantaneous release of high pressure hydraulic fluid and loss of load which can possibly cause serious injury or death.
- Avoid off-center loads which could damage the cylinder or ram and/or cause loss of the load, possibly causing serious injury or death.
- Control the load at all times. Do not drop the load. Especially on locking collar cylinders or rams because the threads may shear and cause loss of the load.
- Properly rated adapters must be installed and used correctly for each application.
- Cylinders with weep hole stroke limiters will expel high pressure oil through the bleed hole to the atmosphere if extended beyond the visual maximum stroke indication. If this occurs, seals must be replaced.

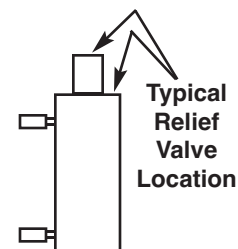
 **WARNING**

- All WARNING statements must be carefully observed to help prevent personal injury.

Hydraulic Hoses and Fluid Transmission Lines

- Avoid straight line tubing connections in short runs. Straight line runs do not provide for expansion and contraction due to pressure and/or temperature changes. See diagrams in Set-up section of this form.
- Eliminate stress in the tube lines. Long tubing runs should be supported by brackets or clips. Tubes through bulkheads must have bulkhead fittings. This makes easy removal possible and helps support the tubing.
- Before operating the pump, all hose connections must be tightened with the proper tools. Do not overtighten. Connections should only be tightened securely and leak-free. Overtightening can cause premature thread failure or high pressure fittings to split at pressures lower than their rated capacities.

SAFETY PRECAUTIONS (CONTINUED)

- Should a hydraulic hose ever rupture, burst, or need to be disconnected, immediately shut off the pump and release all pressure. Never attempt to grasp a leaking pressurized hose with your hands. The force of escaping hydraulic fluid could cause serious injury.
- Do not subject the hose to potential hazard such as fire, sharp surfaces, extreme heat or cold, or heavy impact. Do not allow the hose to kink, twist, curl, crush, cut, or bend so tightly that the fluid flow within the hose is blocked or reduced. Periodically inspect the hose for wear, because any of these conditions can damage the hose and possibly result in personal injury.
- Carefully inspect all hoses and fittings prior to use. Before each use, check entire hose for cuts, leaks, abrasion or bulging of cover, or damage or movement of couplings. If any of these conditions exist, replace the hose immediately. NEVER attempt to repair the hose.
- Do not use the hose to move attached equipment. Stress can damage the hose and possibly cause personal injury.
- Hose material and coupler seals must be compatible with the hydraulic fluid used. Hoses also must not come in contact with corrosive materials such as creosote-impregnated objects and some paints. Hose deterioration due to corrosive materials can result in personal injury. Consult the manufacturer before painting a hose. Never paint a coupler.

Cylinder

- The user must be a qualified operator familiar with the correct operation, maintenance, and use of the cylinder(s). Lack of knowledge in any of these areas can lead to personal injury.
- Read and understand all safety and warning decals and instructions.
- Use only approved accessories and approved hydraulic fluid. Hoses, seals and all components used in a system must be compatible with the hydraulic fluid used.
- Do not exceed the rated capacities of the cylinders. Excess pressure can result in personal injury.
- Inspect each cylinder and coupler before each shift or usage to prevent unsafe conditions from developing.
- Do not use cylinders if they are damaged, altered or in poor condition.
- Do not use cylinders with bent or damaged couplers or damaged port threads.
- Under certain conditions, the use of an extension with a hydraulic cylinder may not be advisable and could present a dangerous condition.
- Avoid pinch points or crush points that can be created by the load or parts of the cylinder.
- To help prevent material fatigue if the cylinder is to be used in a continuous application, the load should not exceed 85% of the rated capacity or stroke.
- The RT1004 cylinder has an internal stroke limiting device which may be damaged by sudden movement of the piston rods. If damage is suspected, have the stroke limiting plunger and spring inspected/replaced by a qualified person.
- Cylinder must be on a stable base which is able to support the load while pushing or lifting.
- To help prevent personal injury, use shims, friction material or constraints to
- Do not create an uneven fulcrum and lever condition or overload condition where force exerted by one cylinder on a lever will intensify downward force on a pressure-checked cylinder at the other end of the lever. *For example: If straightening an axle as illustrated, when cylinder A extends, and uneven fulcrum and lever condition will intensify force downward on pressure-checked cylinder B. The pressure created in cylinder B will be increased to dangerously high levels.*
- prevent slippage of the base or load.
- Do not set poorly-balanced or off-center loads on a cylinder. The load can tip or the cylinder can “kick out” and cause personal injury.
- Do not use the locking collar on a threaded piston as a stop. The threads may shear resulting in loss of the load.
- If this component is used to lift or lower loads, be certain that the load is under operator control at all times and that others are clear of the load. Do not drop the load.
- As the load is lifted, use blocking and cribbing to guard against a falling load.

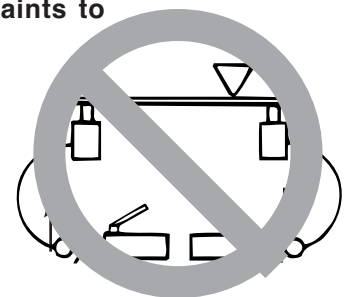
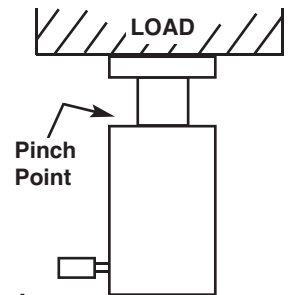

SAFETY PRECAUTIONS (CONTINUED)

- To help prevent personal injury, do not allow personnel to go under or work on a load before it is properly cribbed or blocked. All personnel must be clear of the load before lowering.
- Never use extreme heat to disassemble a hydraulic cylinder or ram. Metal fatigue and/or seal damage will result and can lead to unsafe operating conditions.
- Use extreme caution when disassembling a spring return cylinder. All springs can store energy which can be released suddenly and cause personal injury. Mechanically restrain the gland nut or end cap when disassembling any compressed or extended cylinders which have an internally compressed spring. Consult the parts list to determine the type of spring loading. Observe all warnings and cautions.
- The guide cannot cover every hazard or situation so always do the job with SAFETY FIRST.

IMPORTANT:

- Keep the cylinder clean at all times.
- While at a job site, when the cylinder is not in use, keep the piston rod fully retracted and upside down.
- Use an approved, high-grade pipe thread sealant to seal all hydraulic connections. Teflon tape can be used if only one layer of tape is used and it is applied carefully (two threads back) to prevent the tape from being pinched by the coupler and broken off inside the pipe end. Any loose pieces of tape could travel through the system and obstruct the flow of fluid or cause jamming of precision-fit parts.
- Always use protective covers on disconnected quick couplers.
- When mounting cylinders or rams using the internal piston rod threads, collar threads, threaded tie rods or base mounting holes, the threads must be fully engaged. Always use SAE grade 8 or better fasteners when attaching components to cylinders or rams and tighten securely.
- Limiting the stroke on spring return cylinders will prolong spring life.
- Limiting the stroke and pressure on all cylinders will prolong their life.

INTRODUCTION

These instructions are written to help you, the user, more effectively use and maintain your single-acting or double-acting cylinders and rams. If any questions, please call your nearest AME facility (see listing).

Some of the information included in these instructions was selected from A.N.S.I. B30.1 and applies to the construction, installation, operation, inspection and maintenance of hydraulic cylinders. It is strongly recommended that you read A.N.S.I. B30.1 to answer any questions not covered in these instructions. The complete A.N.S.I. B30.1 standard which contains additional information can be obtained at a nominal cost from the American Society of Mechanical Engineers, United Engineering Center, 345 East 47th, New York, New York 10017.

An inspection checklist (Form No. 105503) is available on request from your nearest AME facility.

SYSTEM EVALUATION

Your cylinder, hose(s), couplings and pump all must be rated for the same maximum operating pressure, correctly connected and compatible with the hydraulic fluid used. An improperly matched system can cause the system to fail and possibly cause serious injury. If you are in doubt, consult your nearest AME facility.

SET-UP

HYDRAULIC CONNECTIONS

Remove the thread protectors or dust covers from the hydraulic ports if applicable. Clean the areas around the fluid ports of the pump and cylinder. Inspect all threads and fittings for signs of wear or damage, and replace as needed. Clean all hose ends, couplers and union ends. Connect all hose assemblies to the pump and cylinder. Use an approved, high-grade pipe sealant to seal all hydraulic connections. Tighten securely and leak-free but do not overtighten.

Hydraulic lines and fittings can act as restrictors as the cylinder or ram retracts. The restricting or slowing of the fluid flow causes back pressure that slows the cylinder's or ram's return. Return speed also varies because of the application, condition of the cylinder or ram, inside diameter of hose or fitting, length of the hose, and the temperature and viscosity of the hydraulic fluid.

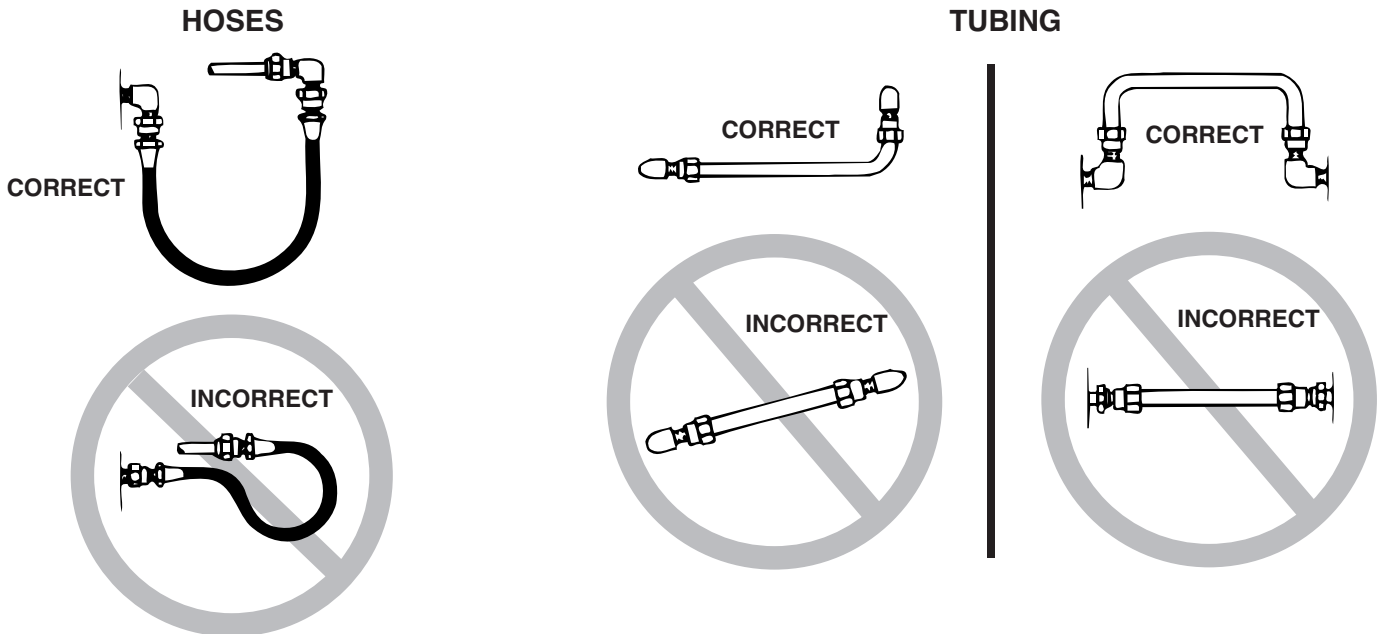

BLEEDING THE SYSTEM

After all connections are made, the hydraulic system must be bled of any trapped air. Refer to the diagrams below.

With no load on the system and the pump vented and positioned higher than the cylinder or ram, cycle the system several times. If you are in doubt about venting your pump, read the operating instructions for your pump. Check the reservoir for possible low fluid level and fill to proper level with approved, compatible hydraulic fluid as necessary.

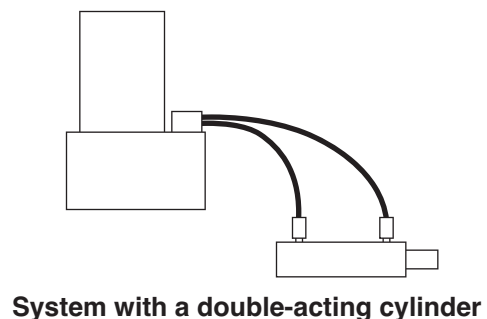
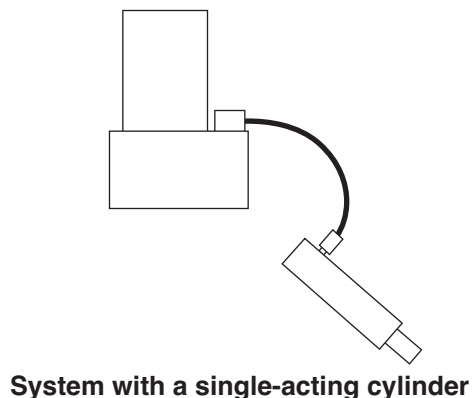

IMPORTANT: Some spring return cylinders or rams have a cavity in the rod which forms an air pocket. This type of cylinder or ram should be bled when positioned upside down or lying on its side with the port facing upward.

SET-UP (CONTINUED)

INSPECTION

Before each use, visually inspect for the following items:

1. Cracked or damaged cylinder
2. Excessive wear, bending, damage, or insufficient thread engagement
3. Leaking hydraulic fluid
4. Scored or damaged piston rod
5. Improperly functioning swivel heads and caps
6. Loose bolts
7. Damaged or improperly assembled accessory equipment
8. Modified, welded, or altered equipment
9. Bent or damaged couplers or port threads

Preventive Maintenance (yearly or sooner, if the cylinder or ram condition suggests damage) - Visual examination by the operator or other designated personnel with a dated and signed equipment record.

RAM AND CYLINDER MAINTENANCE

- Always use clean, approved hydraulic fluid and change as needed.
- Any exposed threads (male or female) must be cleaned and lubricated regularly, and protected from damage.
- If a cylinder or ram has been exposed to rain, snow, sand, grit-laden air, or any corrosive environment it must be cleaned, lubricated, and protected immediately after exposure.

PERIODIC CLEANING

A routine should be established to keep the hydraulic system as free from dirt as possible. All unused couplers must be sealed with dust covers. All hose connections must be free of dirt and grime. Any equipment attached to the cylinder must be kept clean. Change the hydraulic fluid as recommended or sooner if the fluid becomes contaminated (never exceed 300 hours).

STORAGE

Single-acting and Center Hole Cylinders

Single-acting and center hole cylinders and rams should be stored in a vertical position with the rod end down in a **dry**, well-protected area where they will not be exposed to corrosive vapors, dust or other harmful elements.

When a single-acting cylinder or ram has not been used for a period of three (3) months it should be connected to a pump and be fully extended and then retracted. This cycle will lubricate the cylinder walls thereby reducing the potential for rust formation on the cylinder walls.

Double-acting Cylinders

Double-acting cylinders and rams should be stored in a vertical position with the rod end down in a **dry**, well-protected area where they will not be exposed to corrosive vapors, dust or other harmful elements.

If a double-acting cylinder or ram has been stored for a year or more, it must be thoroughly inspected before it is used.

TROUBLE-SHOOTING GUIDE

IMPORTANT:

- The following trouble-shooting and repair procedures should be performed by qualified personnel familiar with this equipment. Use the proper equipment when trouble-shooting!

NOTE:

- All the following statements may not apply to your particular model of cylinder or ram. Use the guide as a general reference for trouble-shooting.

PROBLEM	CAUSE	SOLUTION
Erratic action	<ol style="list-style-type: none"> 1. Air in system or pump cavitation 2. Internal leakage in double-acting cylinders or external leakage in single-acting cylinders 3. Cylinder sticking or binding 	<ol style="list-style-type: none"> 1. Add fluid, bleed air and check for leaks 2. Replace worn packings. Check for excessive contamination or wear. Replace contaminated fluid as necessary. 3. Check for dirt or leaks. Check for bent, misaligned, worn parts or defective packings.
Cylinder/Ram does not move	<ol style="list-style-type: none"> 1. Loose couplers 2. Faulty coupler 3. Improper valve position 4. Low or no hydraulic fluid in pump reservoir 5. Air-locked pump 6. Pump not operating 7. Load is above the capacity of the system 8. Fluid leaks out of rod end relief valve (double-acting cylinders only) 	<ol style="list-style-type: none"> 1. Tighten couplers 2. Verify that female coupler is not locked up (ball wedged into seat). Replace both female and male couplers. 3. Close release valve or shift to new position 4. Fill and bleed the system 5. Prime pump per pump operating instructions 6. Check pump's operating instructions 7. Use the correct equipment 8. Make sure all couplers are fully coupled. Contact your nearest Authorized Hydraulic Service Center.
Cylinder/Ram extends only partially	<ol style="list-style-type: none"> 1. Pump reservoir is low on hydraulic fluid 2. Load is above the capacity of the system 3. Cylinder piston rod binding 	<ol style="list-style-type: none"> 1. Fill and bleed the system 2. Use the correct equipment 3. Check for dirt or leaks. Check for bent, misaligned, worn parts or defective packings.
Cylinder/Ram moves slower than normal	<ol style="list-style-type: none"> 1. Loose connection or coupler 2. Restricted hydraulic line or fitting 3. Pump not working correctly 4. Cylinder seals leaking 	<ol style="list-style-type: none"> 1. Tighten 2. Clean and replace if damaged 3. Check pump operating instructions 4. Replace worn seals. Check for excessive contamination or wear

TROUBLE-SHOOTING GUIDE (CONTINUED)

PROBLEM	CAUSE	SOLUTION
Cylinder/Ram moves but does not maintain pressure	<ol style="list-style-type: none"> 1. Leaky connection 2. Cylinder seals leaking 3. Pump or valve malfunctioning 	<ol style="list-style-type: none"> 1. Clean, reseal with thread sealant and tighten connection 2. Replace worn seals. Check for excessive contamination or wear. Replace contaminated fluid as necessary. 3. Check pump or valve operating instructions
Cylinder/Ram leaks hydraulic fluid	<ol style="list-style-type: none"> 1. Worn or damaged seals 2. Loose connections 3. Rod end relief valve has activated (double-acting cylinders only) 	<ol style="list-style-type: none"> 1. Replace worn seals. Check for excessive contamination or wear. Replace contaminated fluid as necessary. 2. Clean, reseal with thread sealant and tighten connection 3. Make sure all couplers are fully coupled. <ol style="list-style-type: none"> a. <i>If relief valve is still leaking, do not attempt to service this component. Contact your nearest Authorized Hydraulic Service Center.</i>
Cylinder/Ram will not retract or retracts slower than normal	<ol style="list-style-type: none"> 1. Pump release valve closed 2. Loose couplers 3. Blocked hydraulic lines 4. Weak or broken retraction springs 5. Cylinder damaged internally 6. Pump reservoir too full 	<ol style="list-style-type: none"> 1. Open pump release valve 2. Tighten couplers 3. Clean and flush 4. Send to service center for repair 5. Send to service center for repair 6. Drain hydraulic fluid to correct level

WARRANTY INFORMATION

Warranty of this unit will be void on any part if the unit subjected to misuse due to overloading, abuse, lack of maintenance and unauthorized modifications. No warranty – verbal, written or implied – other than the official, published AME new machinery and equipment warranty will be valid with this unit. In addition, it is your responsibility to be aware of existing Federal, State and Local codes and regulations governing the safe use and maintenance of this unit.